

Subminiature Toggle Switches



Specifications:

Contact rating:	max. 48 V AC/DC, 0,4 VA / max. 50 mA min. 20 mV AC/DC, 1 μ A
Contact resistance:	< 50 m Ω
Insulation resistance:	> 500 M Ω at 250 V DC
Dielectric strength:	500 V, 50 Hz for the duration of 1 minute
Operating temperature:	- 20° to + 80° C
Mechanical life:	minimum 60 000 operations
Contacts:	phosphor bronze gold-plated over nickel barrier
Terminals:	PC terminals, crimped phosphor bronze gold-plated over nickel barrier
Material:	case: PBT, meets UL 94 V-0, washable metal parts: nickel-plated brass
Mounting:	on pc-board
Soldering conditions:	auto-soldering – max.: 5 sec \pm 1 sec., 260° C \pm 5° C

Accessories:

Plastic caps	Order number
black	C 3105
green	C 3106
grey	C 3107
yellow	C 3108
red	C 3109
white	C 3110

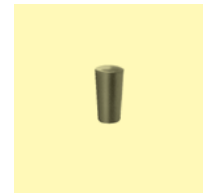
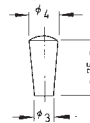

Supporting bracket for	ATE 1.	ATE 2.
Order number	AZ 0001	AZ 0005

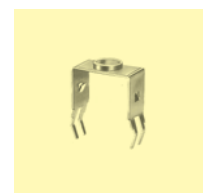
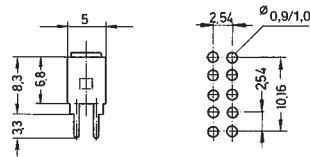
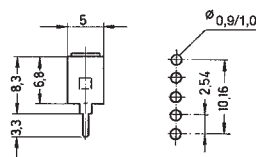



Subminiature Toggle Switches

Models:

Switching functions:
Switching functions F/H/R/T:

the closed contacts are opposite to the lever position;
when looking at the brand name on the right hand side

washable

SPDT

ATE 1 D	on	-	on
ATE 1 E	on	off	on
ATE 1 F	mom	-	on
ATE 1 G	mom	off	mom
ATE 1 H	mom	off	on

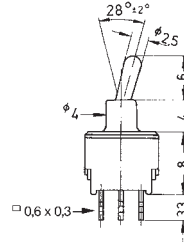
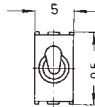

DPDT

ATE 2 D	on	-	on
ATE 2 E	on	off	on
ATE 2 F	mom	-	on
ATE 2 G	mom	off	mom
ATE 2 H	mom	off	on

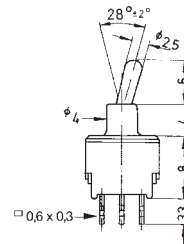
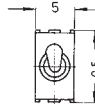
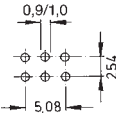

DPDT

ATE 2 N	on	-	on
ATE 2 P*	on	off	on
ATE 2 R*	mom	-	on
ATE 2 S*	mom	off	mom
ATE 2 T*	mom	off	on

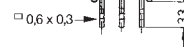
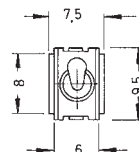
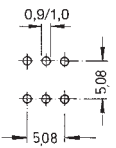

SPDT

ATE 1 D - RA	on	-	on
ATE 1 E - RA	on	off	on
ATE 1 F - RA	mom	-	on
ATE 1 G - RA	mom	off	mom
ATE 1 H - RA	mom	off	on

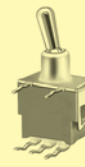
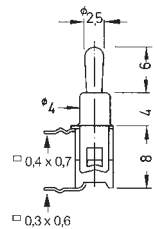
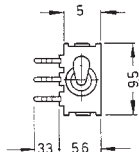
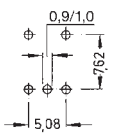

DPDT

ATE 2 D - RA	on	-	on
ATE 2 E - RA	on	off	on
ATE 2 F - RA	mom	-	on
ATE 2 G - RA	mom	off	mom
ATE 2 H - RA	mom	off	on

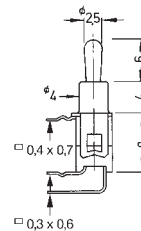
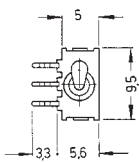
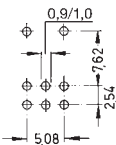

Special versions see page 24.

* Non-stock item; minimum quantity and delivery time on request.

Specifications: see page 22

Models: Switching functions the closed contacts are opposite to the lever position;
Switching functions F/H: when looking at the brand name on the right hand side.

2

SPDT

ATE 1 D – VM	on	–	on
ATE 1 E – VM	on	off	on
ATE 1 F – VM*	mom	–	on
ATE 1 G – VM*	mom	off	mom
ATE 1 H – VM*	mom	off	on

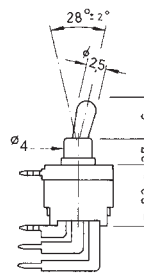
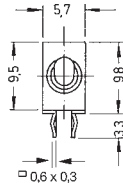
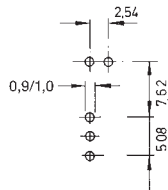

DPDT

ATE 2 D – VM	on	–	on
ATE 2 E – VM	on	off	on
ATE 2 F – VM*	mom	–	on
ATE 2 G – VM*	mom	off	mom
ATE 2 H – VM*	mom	off	on

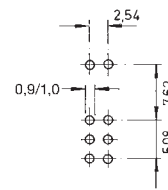

washable

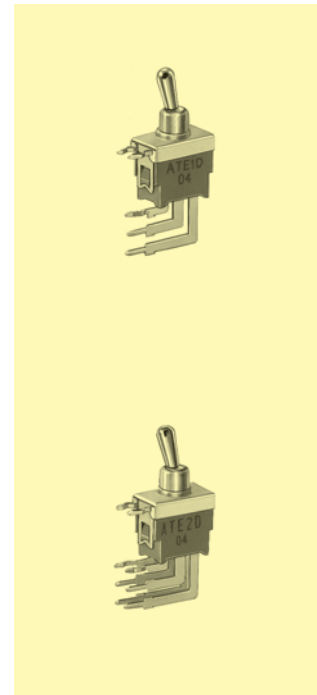

Accessories: see page 22.

Special versions*:

long flat lever

Additional to type number: F
Example of order: ATEF 2D – RA

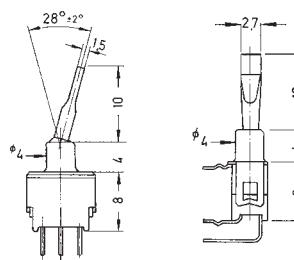

Spacing 5,08 mm

Additional to type number: – 1
Example of order: ATE 2E – RA-1

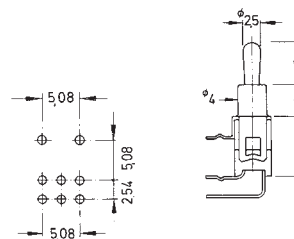

* Non-stock item; minimum quantity and delivery time on request