

CIRCUIT DIAGRAM

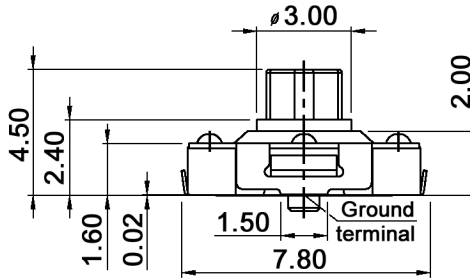

1.40 max.
Fitting margin
for key top

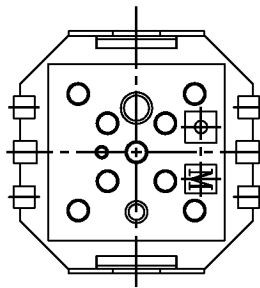
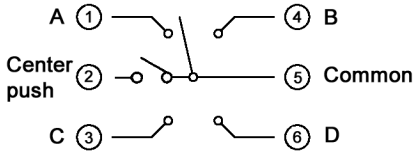
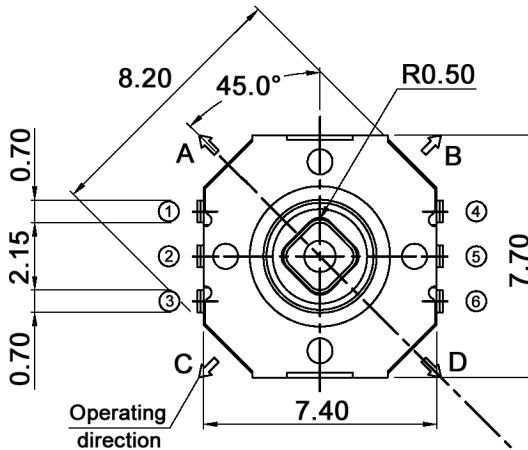
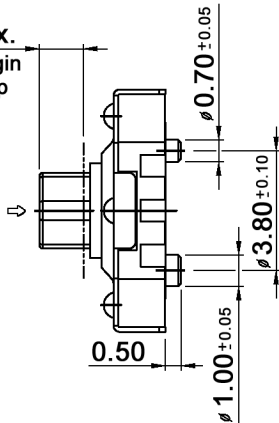

P.C.B. LAYOUT

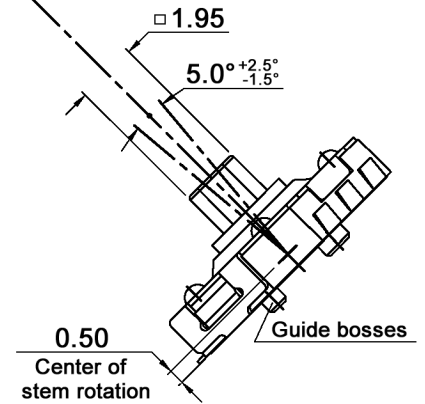
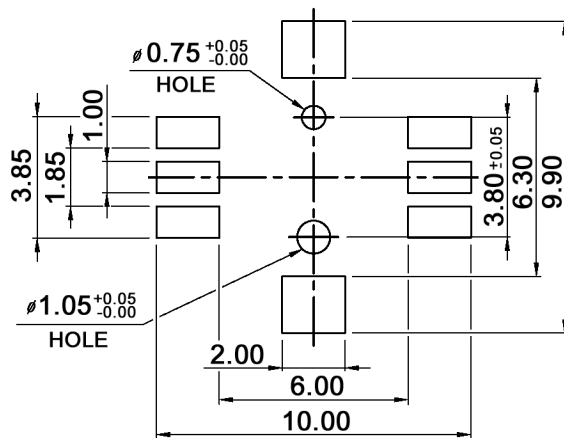

Tolerances:	Date	Name
	09/05	dr
Modifications	Date	Name

TSSJ 5-J

knitter-switch

30 06 40

Page

1/2

Specifications:

Contact rating: 50mA, 12V DC
Contact resistance: 100mOhm max.
Insulation resistance: 100MOhm min.
Dielectric strength: 250V AC (50 or 60 Hz) for 1 minute
Operating temperature: -20°C to +70°C
Storage temperature: -40°C to +85°C
Operating force: center: 320 +/-50g; 4 directions: 160 +/-50g
Mechanical life: 100 000 cycles min.
Soldering temperature: peak 255°C / max. 10sec., >250°C
Travel: (center push) 0.25mm +0.1/-0.2mm
Material: Cover: C7701RH
 Stem: high-temp. thermoplastic LCP
 Contact: SUS301CSP-EH
 Terminal: C5210R-H, silver plated
 Base: high-temp. thermoplastic LCP, black



Tolerances:			Date	Name	TSSJ 5-J	30 06 40	Page
			09/05	dr			
			knitter-switch				2/2
Modifications	Date	Name					