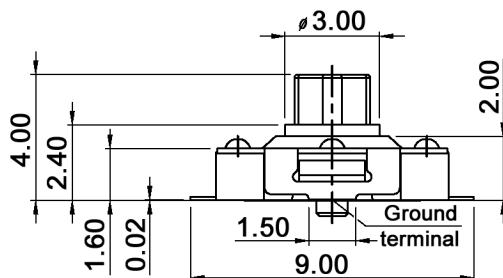
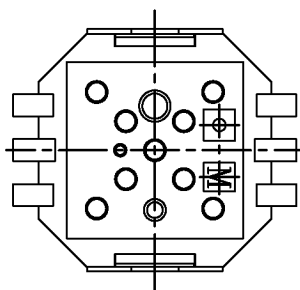
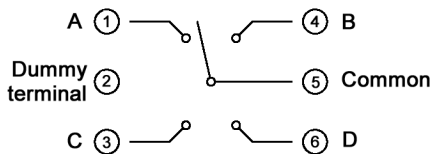
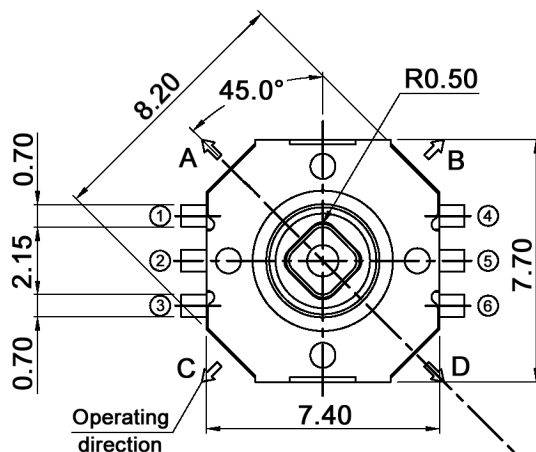
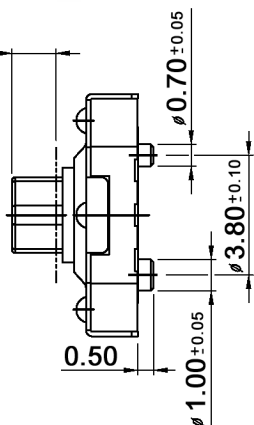

DIAGRAM CIRCUIT



1.40 max.
Fitting margin
for key top



P.C.B. LAYOUT

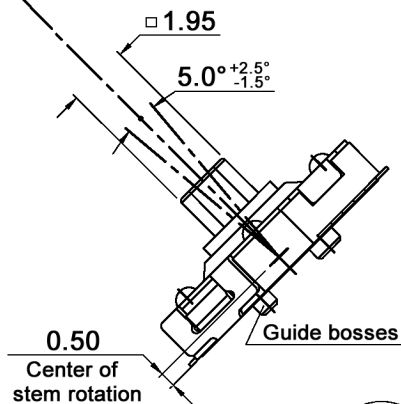
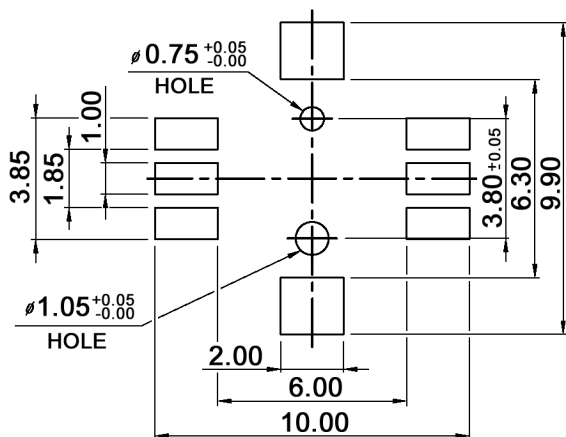

Tolerances: max. ±0.20mm		Date	Name
		09/05	dr
Modifications		Date	Name

TSSJ 4

knitter-switch

30 06 98

Page

1/2

Specifications:

Contact rating: 50mA, 12V DC
 Contact resistance: 100mOhm max.
 Insulation resistance: 100MOhm min.
 Dielectric strength: 250V AC (50 or 60 Hz) for 1 minute
 Operating temperature: -20°C to +70°C
 Storage temperature: -40°C to +85°C
 Operating force: 4 directions: 160 +/-50g
 Mechanical life: 100 000 cycles min.
 Soldering temperature: peak 255°C / max. 10sec., >250°C
 Material: Cover: C7701RH
 Stem: high-temp. thermoplastic LCP
 Contact: SUS301CSP-EH
 Termianl: C5210R-H, with silver plated
 Base: high-temp. thermoplastic LCP, black



Tolerances: max. ±0.20mm			Date	Name	<h1>TSSJ 4</h1>	<h2>30 06 98</h2>	Page 2/2
			09/05	dr			
			knitter-switch				
Modifications	Date	Name					