

Delivery or duplication of this document, and the use or communication of the contents thereof, are forbidden without express authority. Offenders are liable to the payment of damages. All rights are reserved in the event of the grant of a Patent or the registration of a Utility Model.

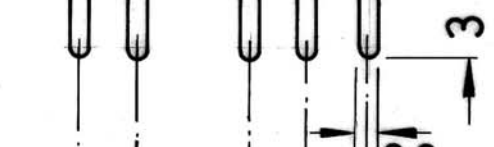
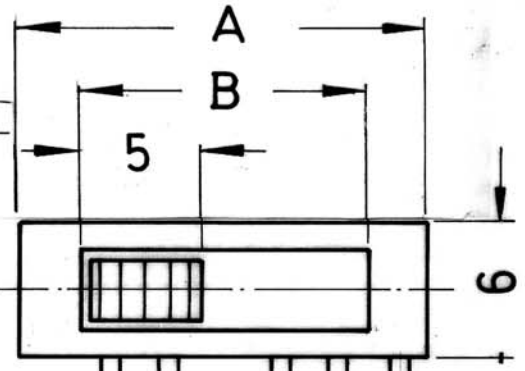
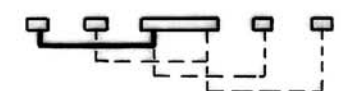
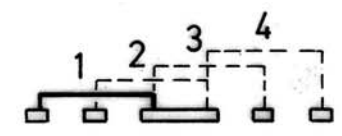
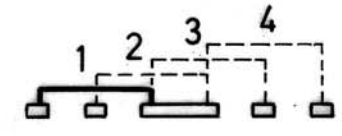
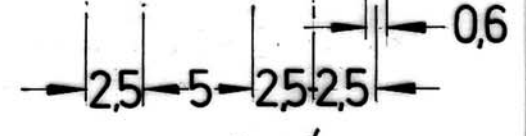
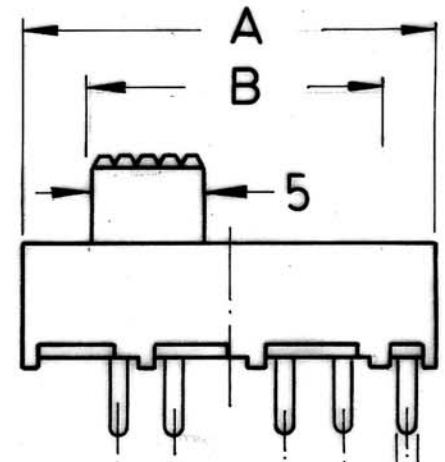
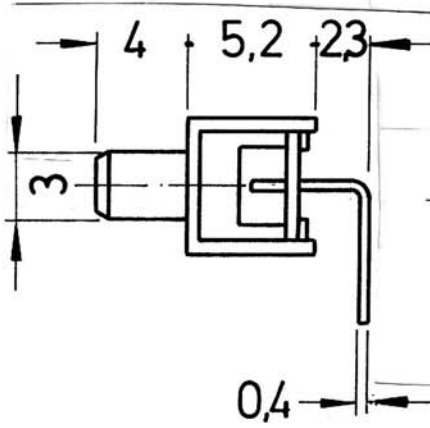
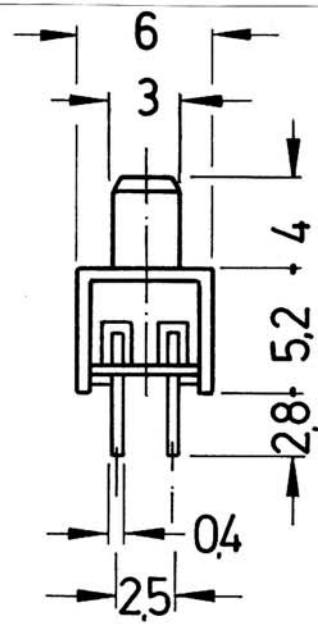
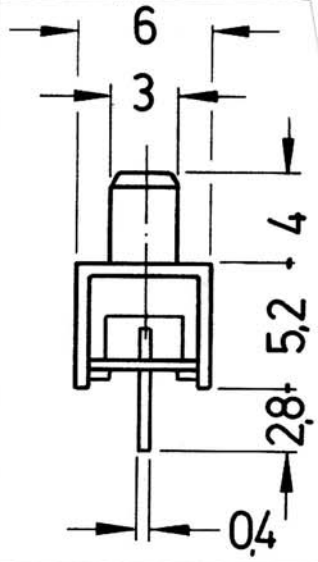
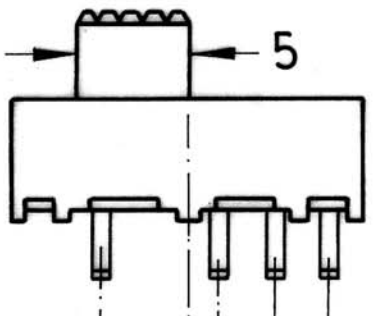
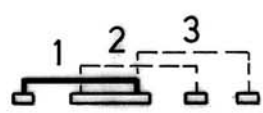
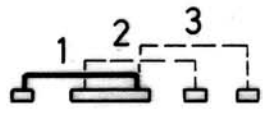
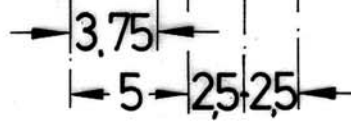
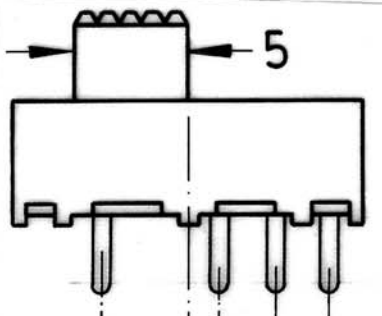

Weitergabe sowie Vervielfältigung dieser Unterlage, Verwertung und Mitteilung ihres Inhalts nicht gestattet, soweit nicht ausdrücklich zugestanden. Zuwiderhandlungen verpflichten zu Schadensersatz. Alle Rechte für den Fall der Patenterteilung oder GM-Eintragung vorbehalten.

				11/87 ey.
TR	Tag	Ausgabe	Mitteilung	Name
			Freigabe:	

MFP	1323(-R) / 1424(-R)
	2323 / 2424
knitter-switch	20 13 68
	M 3 : 1
	Blatt 1
	2 Blätter